

Comparative Performance Analysis of Vapour Compression System under Sub-Cooling and Superheating Conditions with Alternative Refrigerants

Dr. R. Kiran Kumar*

Assistant Professor, Department of Mechanical Engineering, JNTU College of Engineering, Hyderabad, Telangana – 500085

ABSTRACT

This paper presents the simulated results of vapour compression system with sub-cooling and superheating and to compare the system performance for three refrigerants i.e. R22, R410A and R32. For simulation 1 “TR” (Ton of Refrigeration) capacity of air conditioning unit was considered and compared the performance with liquid sub cooling and vapour superheating at different temperature and pressures. For analysis R22 experimental results were considered and simulated for R410A and R32 refrigerants. The simulated results for sub-cooled in the refrigeration system positively affected the system performance and all the investigated refrigerants benefited from the performance improvement. An increase in the sub- cooling and superheating reduced the compressor work input and increased the coefficient of performance. The COP for R22, R410A and R32 are 2.33, 3.36 and 3.63, i.e. with compare to R410A and R22 the refrigerant R32 yields 7.34% and 36% higher COP. The refrigerant charge in to the vapour compression cycle was, for R22, R410A and R32 are 0.8 kg, 0.8 kg and 0.56 kg which determine the size of compressor. For the same operating temperature and pressures the cooling capacity for R32 is higher than the R22 refrigerant. And also reduces the pressure ratio and increases both refrigeration mass flow rate and coefficient of performance.

KEYWORDS: Refrigerant, sub-Cooling, Superheating, mass flow rate, COP, Refrigerant charge

INTRODUCTION

The air-conditioning units which work on the principle of vapour compression system, consists of compressor, condenser, expansion valve and evaporator. A refrigerant is a working medium in the refrigeration system which rejects the heat in condenser. The cycle with sub-cooling and superheating of refrigerant is more advantageous to increase the refrigeration effect which leads to increase the coefficient of performance and reduce the mass flow of refrigerant hence the compressor work reduces [1-3]. Condensers in the air- conditioning units designed to remove the heat absorbed by the refrigerant in the evaporator and heat of compression added by the compressor. This is achieved by transferring heat from the refrigerant vapour discharged by the compressor to some external cooling medium, usually water or air. In the condenser the pressure is maintains constant, but the temperature is constant only during the removal of latent heat from the refrigerant i.e. only in the condensing portion.

THEORETICAL ANALYSIS

The working principle of simple vapour compression refrigeration system is shown in Fig.1. It mainly consists of two units. [4] It is installed such that one unit comprising evaporator faces the room, and the other unit comprising condenser is projected outside the room,

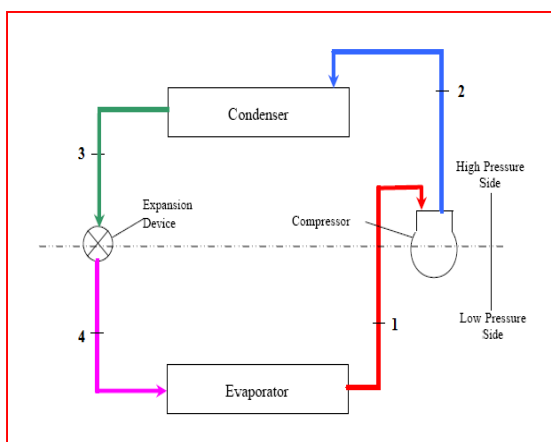

Fig. 1 Simple Vapour Compression system

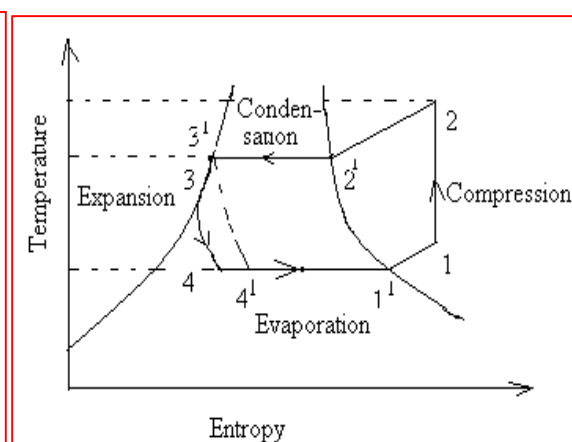

Fig.2 T-s plot with Sub-cooling and Super heating

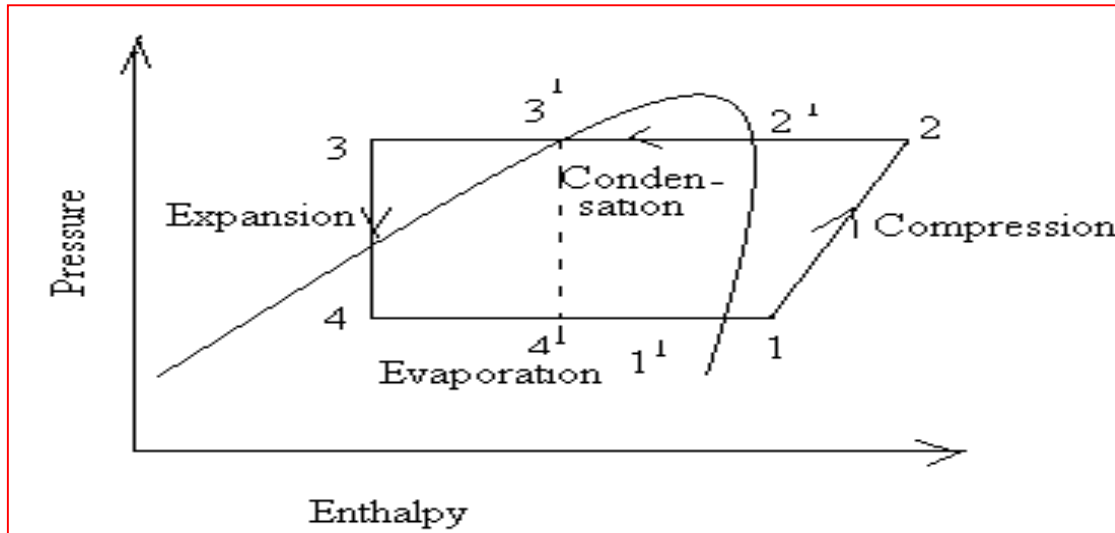

Fig. 3 P-h Plot with Sub-Cooling and super heating

As shown in Fig. 2 & 3 the P-h diagram (Moeller diagram) for refrigeration cycle with four basic processes are frequently used in the analysis of vapour compression refrigeration cycle, process 1to 2 is compression, process 2 to 3 heat rejection in the condenser, process 3 to 4 expansion (Throttling) and process 4 to 1 is Evaporation i.e. heat absorbed in the evaporator. [5-6] described the performance of air conditioner components. The performance characteristics are can be computed for compressor work (Wc), Refrigeration Effect (QE) and Coefficient of Performance (COP) is expressed by the ratio of amount of heat taken by the cold body to the amount of work supplied by the compressor; this ratio is called Coefficient of performance. The system performance is calculated as follows:

The work done during the isentropic compression per kg of refrigerant is given by

$$W_c = m_r \times (h_2 - h_1) \text{ ----- (1)}$$

The refrigerant effect or heat absorbed or extracted by the liquid-vapour refrigerant during evaporation per kg of refrigerant is given by

$$Q_E = m_r \times (h_1 - h_4) \text{ -----(2)}$$

The Coefficient of performance (C.O.P.) is the ratio of heat extracted in the refrigerator to work done on the refrigerator.

$$COP = \text{Refrigeration Effect/ Work Done ----- (3)}$$

$$COP = \frac{h_1 - h_4}{h_2 - h_1} \text{ ----- (4)}$$

$$\text{Pressure ratio} = \frac{P_c}{P_e} \text{ ----- (5)}$$

$$\text{Energy Efficiency Ratio (EER)} = 3.5 \times COP \text{ ----- (6)}$$

$$\text{Capacity of the system} = 1 \text{ TR} = 3.5 \text{ kW} \text{ ----- (7)}$$

$$\text{Heat rejected in the condenser} = m_r \times (h_2 - h_3) \text{ ----- (8)}$$

$$\text{Heat absorbed in the evaporator} = m_r \times (h_1 - h_4) \text{ ----- (9)}$$

Where,

h_1 and h_2 are enthalpies of refrigerant at the inlet and outlet of compressor (kJ/kg).

$h_3 = h_4$ are enthalpies of refrigerant at the inlet and outlet of expansion valve (kJ/kg).

For the air conditioning system of 1 TR capacity, with the following operating conditions the Performance of the system can be computed as:

The operating conditions have been chosen for condenser temperature of 54.5°C and evaporator temperature 7.2°C for selected three different type's refrigerants (R22, R32 and R410A) in vapour compression cycle. [7-9] explained the different studies of vapour compression cycle analysis.

By using P-h chart of R32 the following properties obtained are

Enthalpy of the refrigerant at entry to compressor is $h_1 = 500$ kJ/kg

Enthalpy of the refrigerant at the at outlet of the compressor is $h_2 = 555$ kJ/kg

Enthalpy of refrigerant at outlet of the expansion valve $h_3 = h_4 = 315$ kJ/kg

Pressure at the in the evaporator = 10.1 bar

Pressure in the condenser = 34.1 bar

From the equation

$$COP = \frac{h_1 - h_4}{h_2 - h_1} = \frac{500 - 315}{555 - 500} = 3.36$$

$$\begin{aligned} \text{Pressure ratio} &= \frac{p_c}{p_e} = 3.37 \\ \text{Energy Efficiency Ratio (EER)} &= 3.5 \times \text{COP} \\ &= 11.76 \\ \text{Capacity of the system} &= 1 \text{ TR} = 3.5 \text{ kW} \\ \text{The net refrigeration effect} &= m_r \times (h_1 - h_4) \\ &= 3.5 \text{ kW} \\ \text{Mass flow rate of refrigerant} &= 3.5 / (h_1 - h_4) \\ \text{Mass flow rate of refrigerant} &= 0.0189 \text{ kg/s} \\ \text{Compression work} &= m_r \times (h_2 - h_1) \\ &= 0.0189 \times (h_2 - h_1) \\ &= 1.03 \text{ kW} \\ \text{Heat rejected in the condenser} &= m_r \times (h_2 - h_3) \\ &= 4.53 \text{ kW} \\ \text{Heat absorbed in the evaporator} &= m_r \times (h_1 - h_4) \\ &= 3.49 \text{ kW} \end{aligned}$$

The refrigeration capacity by of refrigeration is its cooling capacity or heat transfer rate that it can provide for cooling. The SI unit for the heat transfer rate is kW, however, the refrigeration capacity is still measured in “Ton of Refrigeration (TR)”. One ton of refrigeration is equivalent to 3.5kW, and i.e. the heat is removed from the substance to produce cooling effect.

The system thermodynamic performance parameters are measured in terms of COP, where as the system appliance rating is measured in energy efficiency ratio (EER).It is ratio between net cooling capacities (Btu/hr) to the total electrical input (W) under designed operating conditions. The performance rating of compressors is reviewed by ARI, [10-12]. The relation between Coefficient of performance (COP) and Energy Efficiency Ratio (EER) can be written as $EER = 3.5 \times COP$.

SIMULATION ANALYSIS

For simulation, REFPROP version 6.01 (REFPROP is an acronym for Refrigerant Properties) used for finding out the properties of Refrigerant 32, which gives the most accurate pure fluid property for simulation, developed by the National Institute of Standards and Technology (NIST) provides the thermodynamic and transport properties of refrigerants [13-14].REFPROP also provides high accuracy data for pure refrigerants and refrigerant mixtures.

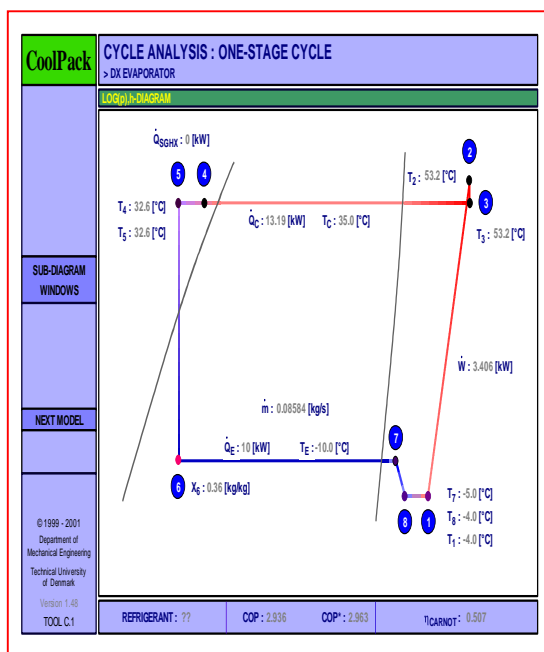

Fig. 4 Simulation of vapour compression cycle

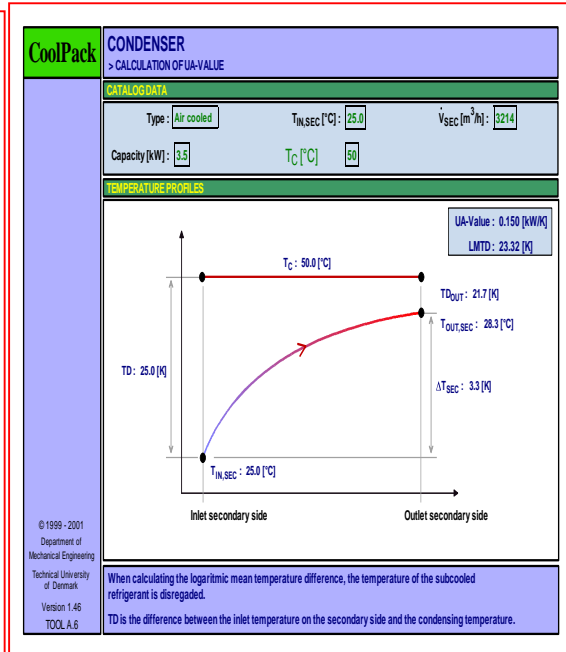

Fig.5 simulation of condenser performance

Cool Pack (version 1.49) is a collection of simulation programs used for designing, dimensioning, analyzing and optimizing the refrigeration system, it consist of three main group Refrigeration Utility ,EES Cool Tool, Dynamic analysis Tool. EES provides high accuracy property data for pure refrigerant and refrigerant mixtures and used to

analyses Cycle performance, System Dimensioning, Operation analysis, System Simulation and Comparison of Refrigerants.

Single stage vapour cycle simulation are shown in Fig.4 & 5, the test conditions are according to ASHRAE, ISO and other standards the data are often presented with a high suction gas superheat and all of this superheat is considered (included in the refrigeration capacity). In this model, the testing situation is specified by setting the input parameters like temperature, displacement volume flow rate and capacity are used for analysis. The f_Q is the ratio between the heat loss of the compressor to the surroundings and energy consumption of the compressor. The value of f_Q does not any influence on the capacity or Efficiency of the Compressor. It only determines the discharge temperature of the compressor. The model can also be used to calculate the compressor performance of other operating conditions (e.g. different values for superheat and sub cooling). This part of the calculations assumes that isentropic and volumetric efficiencies are constant.

The Programs in cool pack covers following simulation purpose:

- Calculation of Refrigeration Properties (Property plots, thermodynamic and Thermo-physical data, Refrigerant Comparisons).
- Cycle Analysis –Compression of single Stage and Multi Stage.
- System dimensioning–Calculation of component sizes from general configuration criteria.
- System Simulation–Calculation Operating conditions in a system with known components with their operating parameters.
- Evaluation of Operation–Evaluation of the system Coefficient of Performance with less power consumption.

RESULTS AND DISCUSSION

Suitability of a refrigerant for a certain application is determined by its physical, thermodynamic, chemical properties and by various practical factors. Table 1 show that simulated and experimental comparison of selected tree refrigerants. There is no one refrigerant which can be used for all types of applications i.e. there is no ideal refrigerant. Hence, a refrigerant is chosen which has greater advantage and fewer disadvantages.

Table 1 .Simulated and experimental Comparison of selected refrigerants

Condenser Temperature (°C)	Evaporator Temperature (°C)	Coefficient of performance			Cooling capacity(kW)			Maas flow rate (kg/s)		
		R-22	R-410A	R-32	R-22	R-410A	R-32	R-22	R-10A	R-32
35	-10	1.27	1.93	2	2.737	4.059	4.32	0.015	0.021	0.0151
	0	1.8	2.73	2.8	3.86	5.64	6.05	0.022	0.030	0.022
	10	2.5	3.7	3.8	5.3	7.67	8.2	0.030	0.042	0.0307
40	-10	1.22	1.86	1.9	2.64	3.89	4.16	0.015	0.021	0.0151
	0	1.75	2.62	2.71	3.72	5.4	5.83	0.0215	0.029	0.022
	10	2.42	3.6	3.76	5.135	7.3	7.9	0.0302	0.042	0.0307
45	-10	1.189	1.78	1.85	2.544	3.7	4.04	0.015	0.0208	0.0151
	0	1.68	2.51	2.62	3.589	5.15	5.61	0.0215	0.0298	0.0217
	10	2.33	3.46	3.63	4.93	6.94	7.6	0.0302	0.042	0.0307
50	-10	1.15	1.7	1.79	2.44	3.5	3.86	0.015	0.0208	0.0151
	0	1.62	2.4	2.53	3.447	4.87	5.39	0.0215	0.0298	0.022
	10	2.254	3.3	3.5	4.73	6.56	7.3	0.0302	0.042	0.0307
55	-10	1.104	1.62	1.27	2.343	3.31	3.71	0.015	0.0208	0.0151
	0	1.56	2.27	2.43	3.3	4.58	5.16	0.0215	0.0298	0.0217
	10	2.16	3.134	3.367	4.53	6.146	7	0.0302	0.0422	0.0307
60	-10	1.06	1.52	1.166	2.23	3.01	3.54	0.015	0.0208	0.0151
	0	1.52	2.14	2.33	3.15	4.3	4.9	0.0215	0.0298	0.0151
	10	2.08	2.94	3.22	4.32	5.69	6.66	0.0302	0.0422	0.0307

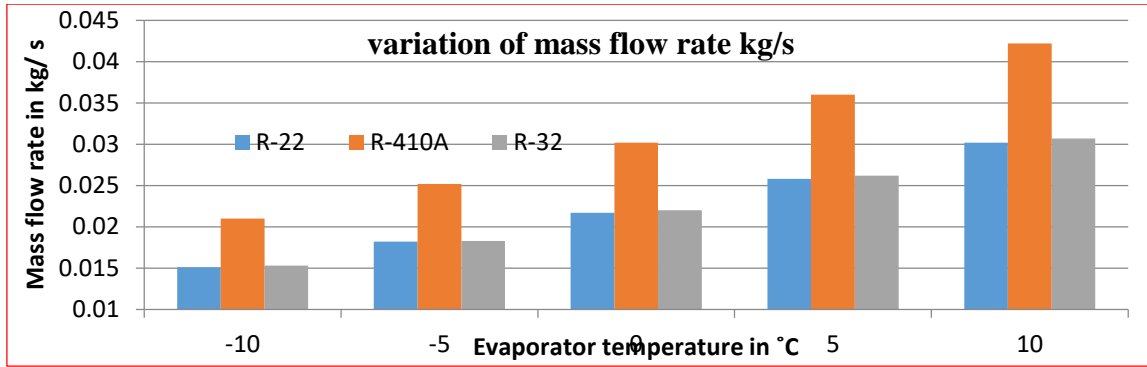

Fig. 6 Mass flow rate evaporator temperature

Figure 6, shows the variation of mass flow rate with different evaporator temperatures (Suction Pressure) Mass flow rate required for Refrigerant 32 is 41% less with compare to R-410A, hence there will be less loads on to the compressor with minimum energy (power) required for compression processes, this will be advantageous for eco-friendly refrigerant.

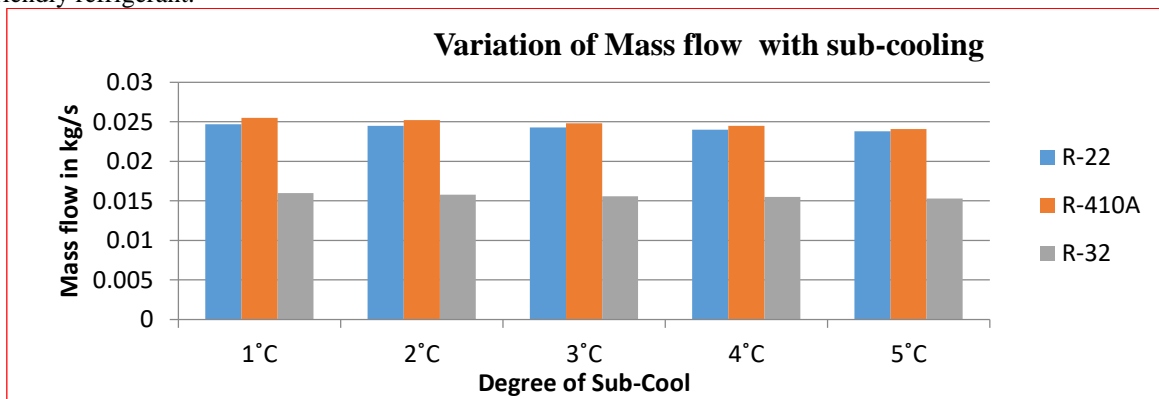

Fig.7 Mass flow rate with liquid sub- cooling

Figure 7, shows the variation of mass flow with sub-cooling; Sub-cooling of refrigerant is always good. It is observed that for the condenser temperature with 5°C sub-cooling the mass flow rate for R32 is very less i.e. 0.0153 kg/s and for R410A and R22 are 0.0241kg/s, hence, the refrigeration effect increases per kg of refrigerant circulated in the refrigeration cycle. Since the refrigeration effect is more the amount of refrigerant circulated can be reduced. As the mass flow rate is less the volume of vapour handled by the compressor is less per TR, COP is improved as the refrigeration effect is increased.

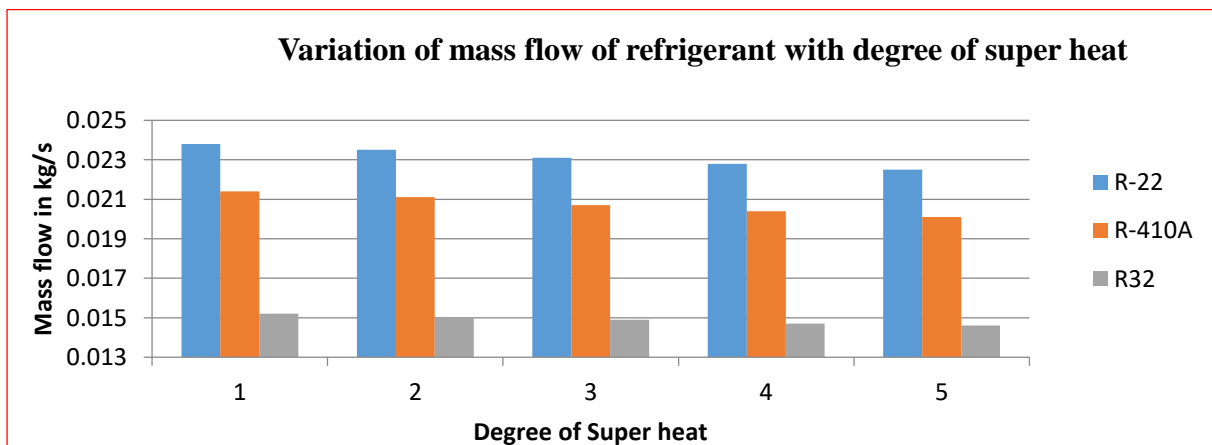

Fig. 8 Variation of mass flow with degree of super heat

Figure 8, shows the effect of degree of super heat because superheating of suction vapour is always good because the degree of super heat serves as means of actuating and modulating capacity of the expansion valve also dry

compression possible .As shown in figure the mass flow rate for R32 low compare to the other two refrigerants . Hence the refrigeration effect increases and also increases specific volume of suction vapour.

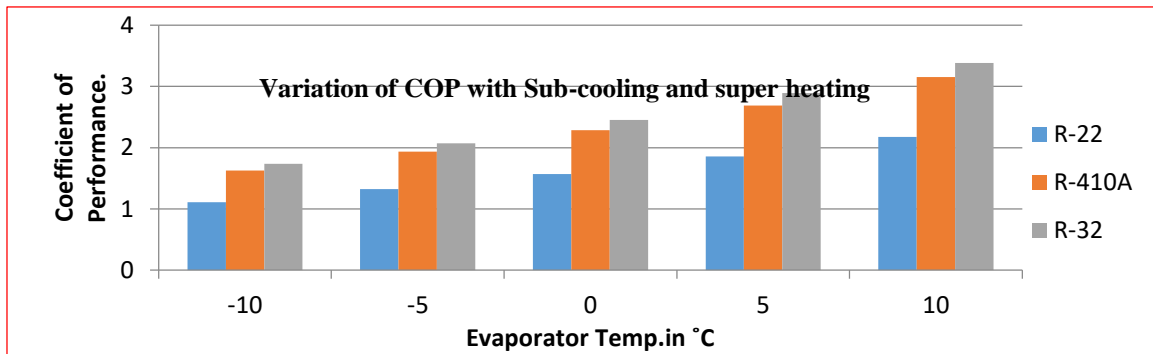

Fig.9 COP for different evaporator temperature.

Fig 9 shows the variation of COP, with evaporator temperature (Suction pressure) the COP of the refrigerant R32 is 3.381 and R22 is 3.15 and R410A 2.17. It is observed that for the same condenser and evaporator temperatures the R32 COP is 36% high with R410A. It is also observed that the trend of COP is decreases with decrease in evaporator temperature, the COP for R32 and R22 refrigerants are nearly equal at higher evaporator temperature COP is more for less compression work.

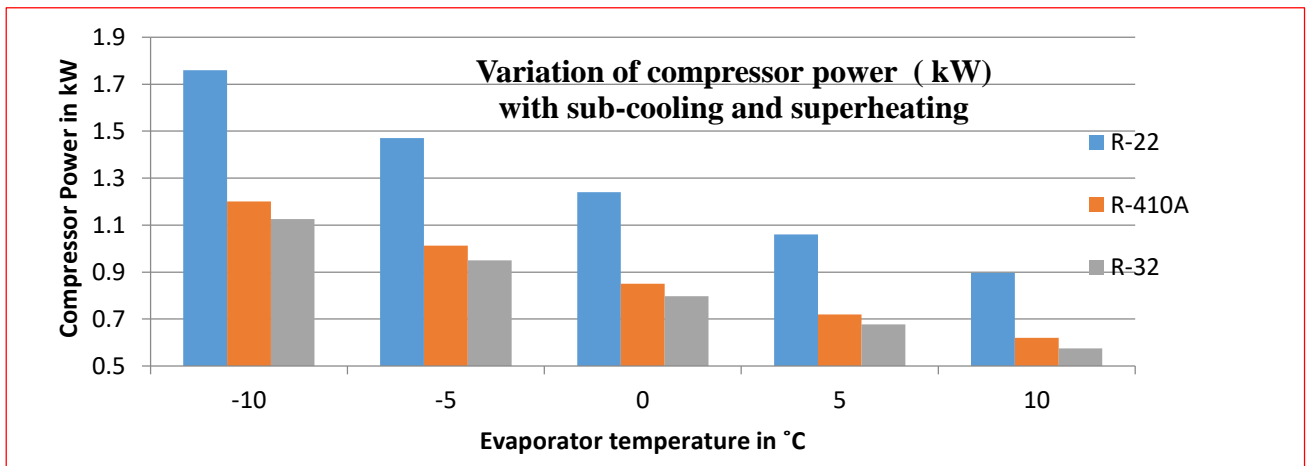

Fig. 10 Compressor power consumption

Fig.10 shows the power consumption of selected refrigerants with the decrease in evaporator temperature, the work of compressor increases and mass of refrigerant circulated per minute decreases which results in increase of compressor power it is observed from the figure that power consumption for refrigerant 22 is very high where as R32 and R410A consumes low power for fixed condenser temperature and for different evaporating temperatures. R22 requires 1.76kW of power and R32 and R410A refrigerants requires slightly same power (i.e. 0.61 kW) per “TR”.

CONCLUSIONS

The simulated results obtained showed for the different evaporator and condenser temperatures for sub cooling and superheating, the obtained simulated results were compared with experimental results of R22 and drawn the following conclusions.

- The COP for R22, R410A and R32 are 2.33, 3.36 and 3.63, i.e. with compare to R410A and R22 the refrigerant R32 yields 7.34% and 36% higher COP.
- The refrigerant charge in to the vapour compression cycle was required for R22, R410A and R32 are 0.8 kg, 0.8 kg and 0.56 kg which determine the size of compressor.
- For the same operating temperature and pressures the cooling capacity for R32 is higher than the R22 refrigerant. And also reduces the pressure ratio and increases both refrigeration mass flow rate and coefficient of performance.
- Power consumption for refrigerant 22 is very high where as R32 and R410A consumes low power

for fixed condenser temperature and for different evaporating temperatures. R22 requires 1.76kW of power and R32 and R410A refrigerants requires slightly same power (i.e. 0.61 kW) per “TR”.

- The sub-cooling of refrigerant in the refrigeration system positively affected the system performance and all the investigated refrigerants benefited from the performance improvement.
- An increase of sub-cooling and superheating which significantly reduces the compressor work input and increases the coefficient of performance.
- There is no one refrigerant which can be used for all types of applications i.e. there is no ideal refrigerant. Hence, a refrigerant is chosen which has greater advantage and fewer disadvantages.

REFERENCE

- [1] S.Devotta, A.S. Padalkar, N.K. Sane, 2005. Performance assessment of HC-290 as a drop-in substitute to HCFC-22 in a window air conditioner,” International Journal of Refrigeration, (28), pp.594–604.
- [2] ASHRAE, Thermo physical Properties of Refrigerants Chapter 20, ASHRAE Fundamentals.
- [3] HVAC Handbook-2007 Indian Society of Heating Refrigerating and Air – Conditioning Engineers, Part I-Air Conditioning.
- [4] B.O.Bolaji, M.A. Akintundeand T.O.Falade,2011, “Comparative Analysis of Performance of three Ozone- Friends HFC Refrigerants in a Vapour Compression Refrigerator”, Journal of Sustainable Energy & Environment (2), pp: 61-64.
- [5] M.Yilmaz, 2002. Performance analysis of a vapour comparison heat pump using Zeotropic Refrigerant mixture. Energy Conversion and Management. (44), pp: 267-282.
- [6] BukolaOlalekanBolaji, 2011. Performance investigation of ozone friendly R404A and R507 refrigerant as alternatives to R22 in a window air conditioner. Journal of Energy and Building. pp: 3139-3143.
- [7] C.Aprea, A Greco, 2003. Performance evolution of R22 and R407c in a vapour compression. Applied Thermal Engg. 23, pp: 215-227.
- [8] Boumaza, M. M., 2007. A numerical Investigation and Comparison of Chlorines Compounds Refrigerants and their Potential Substitutes Operating at High Ambient Temperature Case for the Replacement of R22.
- [9] B.Hadya.,et al.“Performance Assessment of HFC Group Refrigerants in Window Air Conditioning System”,International Journal of Mechanical Engineering and Applications (IJMEA), Science Publishing Group, USA, August 2015. ISSN 2330-0248, Vol 3, issue 5,pp;81-85.
- [10] ARI., 2004. Performance Rating of Positive Displacement Refrigerant Compressors and Compressor Units, Std. 540-2004 Air-Conditioning and Refrigeration Institute, USA.
- [11] P.Carlescu, E. Rakpsi, Gh. Manolache, 2007. Assessment of the sub-cooling capabilities of a thermoelectric device in a vapour compression refrigeration system. University of Agricultural Sciences and Veterinary Medicine.
- [12] Kim SG, Kim MS, Ro ST, Youn B., 1997. Performance characteristics of R-22 and R-407C in a capillary tube of air conditioner. In: Proceedings of the 10th International Symposium on Transport Phenomena (ISTP-10), Kyoto, Japan.
- [13] ASHRAE, 2001. Thermo physical Properties of Refrigerants Chapter 20, ASHRAE- Fundamental. Inc.Atlanta. pp. 1-67.
- [14] REFPROP version 6.01 AND Cool Pack Version 1.49 Refrigeration and Air Conditioning Simulation.